

1-MOTOR SHAFT - CYLINDER

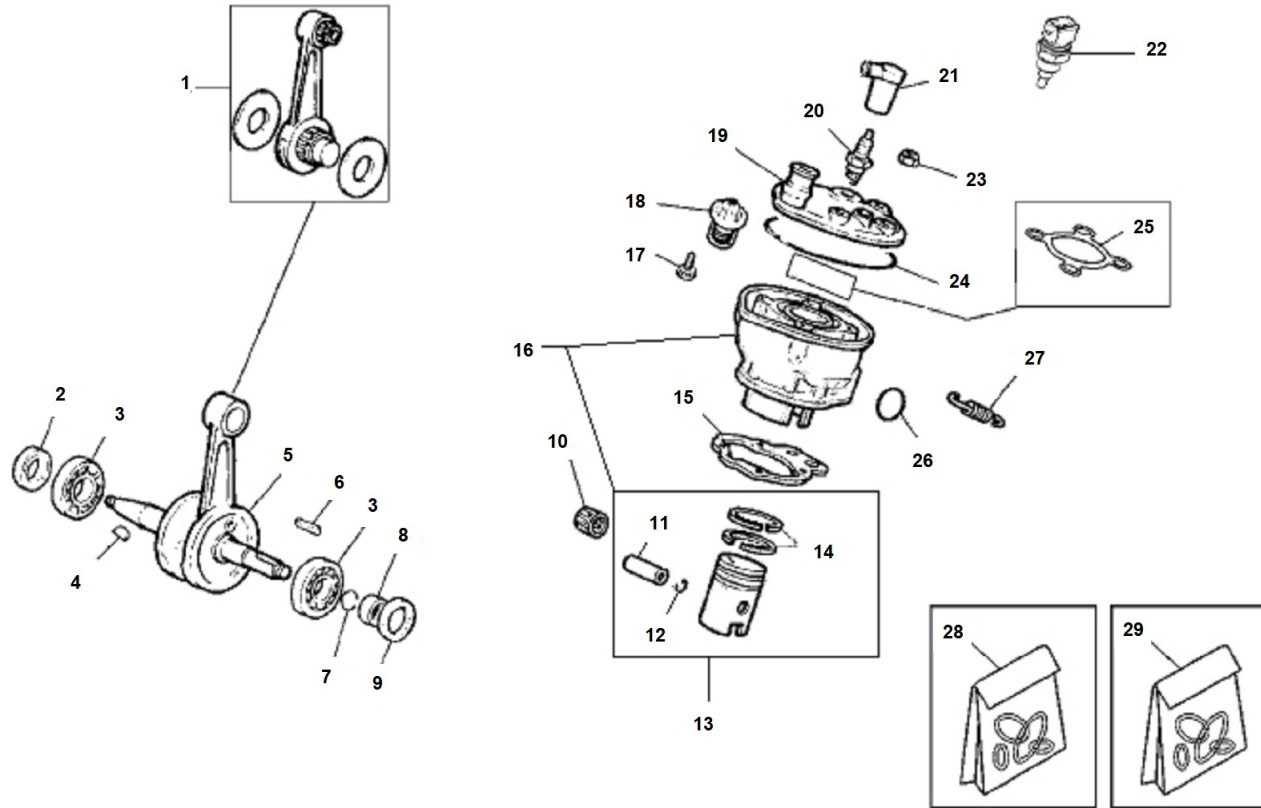

1-MOTOR SHAFT - CYLINDER

N.		Part n°	Description	Notes	Notes	Taxable price (€)
1		7150780	IMBIELLAGGIO SPIN. 16			249,59
2		5305674	PARAOLIO SB2 D.17X35X8 FERRO			6,98
3		93306303X	CUSCINETTO D.17X47X14			11,83
4		4901248	CHIAVETTA 3X3,7X10			3,06
5		13CE1400	IMBIELLAGGIO			178,28
6		4901180	CHIAVETTA 4X4X20 PER PIGNONE			3,38
7		5301047	ANELLO OR 12,5X1,5			2,84
8		4904663	DISTANZIALE ALBERO			12,79
9		5305675	PARAOLIO BAUM3X7 D.25X35X7			15,44
10		5103029	GABBIA 12X15X15			13,67
11		5606302	SPINOTTO D.12 X 34,5			8,34
12		0302247	ANELLO FERNO SPINOTTO D 14			2,87
13		7112300	PISTONE COMPLETO			78,29
13		7116297	PISTONE COMPLETO +0,25 MM	+ 0,25		91,14
13		7116298	PISTONE COMPLETO	+ 0,50		15,00
14		7142110	SERIE SEGMENTI			36,79
14		7147117	SERIE SEGMENTI +0,25 MM	+ 0,25		43,88
14		7147118	SERIE SEGMENTI +0,50 MM	+ 0,50		43,88
15		5308020	GUARNIZIONE BASE CILINDRO			3,45
16		7182947	CILINDRO COMPLETO			206,02







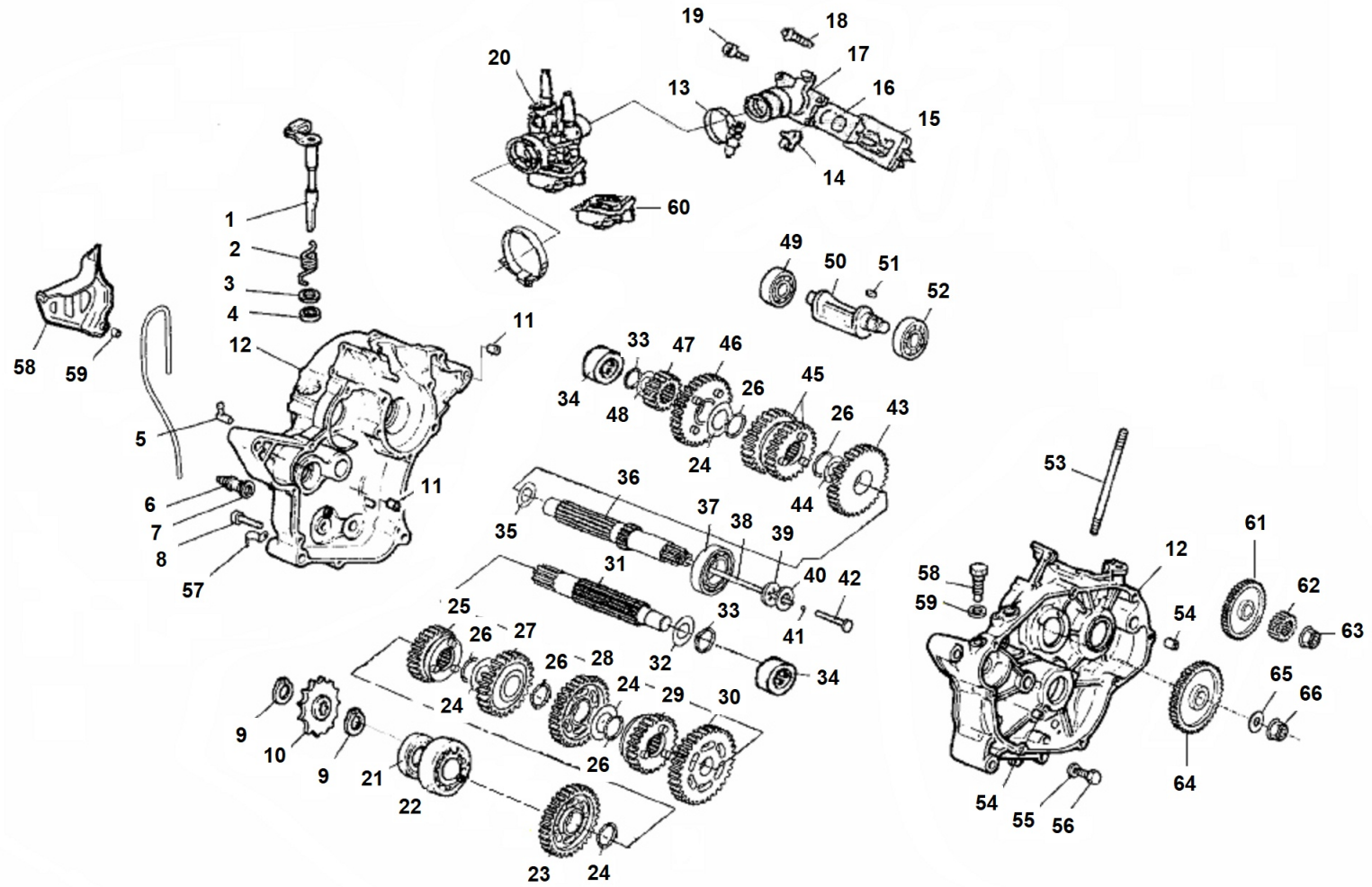











1-MOTOR SHAFT - CYLINDER

N.		Part n°	Description	Notes	Notes	Taxable price (€)
17		4908460	VITE TCB M4X10			0,69
18		5601993	TERMOSTATO PRICOL			23,37
19		7705240	TESTA CRE 50 B/D-RR			45,54
20		1101593	CANDELA			21,65
21		KMM12010	CAPPUCCIO CANDELA			10,92
22		5601991	SONDA TEMPERATURA ACQUA			32,50
23		4903570	DADO M7X1 CIECO			0,69
24		5301749	GUARNIZIONE D.2,62 (EST.)TESTA			4,67
25		5301739	GUARNIZIONE D.2,62 (INT.)TESTA			2,78
26		5301759	ANELLO OR D.25,7X2,62 "VITON"			1,39
27		K03613700	MOLLA MARMITTA			0,90
28		7106871	KIT GUARNIZIONI "AM 6"			45,02
29		7107266	SERIE PARAOLI "AM 345"			36,31

2-MOTOR CARTER - GEARBOX



2-MOTOR CARTER - GEARBOX

N.		Part n°	Description	Notes	Notes	Taxable price (€)
1		4YVE6381	LEVA FRIZIONE COMPLETA			33,78
2		4602200	MOLLA RICHIAMO LEVA FRIZIONE			4,56
3		4907010	RONDELLA IN FERRO D.14X26X0,5			2,76
4		5305029	PARAOLIO 15X24X5			6,54
5		1506489	RACCORDO SFIATO OLIO			3,48
6		5603570	INTERRUTTORE SPIA FOLLE COMPL.			13,52
7		5304790	GUARNIZIONE D.9,9X16X1			0,69
8		90110066	VITE TCCE M6X40			3,01
9		0303127	ANELLO SEEGER PER ALBERO D.20			3,06
10		K01295011	PIGNONE Z 11	Z11		20,84
10		K01295012	PIGNONE Z 12	Z12		20,48
10		K01295013	PIGNONE Z 13	Z13		22,58
11		5602580	GRANO RIFERIMENTO CARTER			1,39
12		7101607	COPPIA CARTER K/S-IMBOCCO D.55			401,59
13		9045032X	FASCETTA			0,00
14		6501410	PASSACAVO FRIZIONE			6,95
15		6000876	VALVOLA LAMELLARE			34,55
16		5WXE3625	INSERTO VALVOLA LAMELLARE			0,00
17		4YVE3565	COLLETORE D.20			33,20
18		4919213	VITE TCB M6X20			0,00

2-MOTOR CARTER - GEARBOX

N.		Part n°	Description	Notes	Notes	Taxable price (€)
19		4919642	VITE T.C.C.E M6X22 ZN. GIALLA			0,69
20		1557174	CARBURATORE PHBN16 AM6 EU-5			267,59
21		5305499	PARAOLIO			6,95
22		93306254	CUSCINETTO D.20X47X14			11,83
23		13CE722100	INGR.2°VEL.SU SECONDARIO Z33			45,69
24		4917621	RONDELLA RASAMENTO SP. 1,0			4,23
25		4003737	INGR. 6°VEL.SU SECONDARIO Z24	Z24		61,12
26		0303364	ANELLO SEEGER 20 MM			5,07
27		4003735	INGRANAGGIO CONDOTTO 4A Z27	Z27		53,99
28		4003734	INGRANAGGIO CONDOTTO 3A Z29	Z29		57,30
29		4003736	INGR. 5° VEL. SU SECONDARIO			59,28
30		4003732	INGR. 1°VEL.SU SECONDARIO Z36	Z36		46,53
31		13CE742100	ALBERO SECONDARIO			138,81
32		9020916X	RONDELLA RASAMENTO			0,00
33		0303365	ANELLO SEEGER 14 MM			4,19
34		93317214	ASTUCCIO A RULLI			11,73
35		4917618	RONDELLA RASAMENTO SP. 0,5			5,00
36		0103396	ALBERO PRIMARIO			118,74
37		5102059	CUSCINETTO 6203			18,61
38		5601460	ASTA FRIZIONE			7,25

2-MOTOR CARTER - GEARBOX

N.		Part n°	Description	Notes	Notes	Taxable price (€)
39		4603010	MOLLA A DISCO			3,90
40		4906520	RONDELLA			3,06
42		5605510	SPINGIDISCO			6,03
43		4003730	INGR. 5° VEL. SU PRIMARIO			43,00
44		4917618	RONDELLA RASAMENTO SP. 0,5			5,00
45		4003729	INGR. 3-4° VEL. SU PRIMARIO			66,96
46		4003731	INGR. 6° VEL. SU PRIMARIO Z25			39,73
47		4003738	INGRANAGGIO 2°VEL.SU PRIMARIO			32,93
48		4917623	RONDELLA 14X22X1 SU PRIMARIO			3,97
49		933A6202	CUSCINETTO D.15X35X11			8,82
50		0109062	CONTRALBERO			42,45
51		4901120	CHIAVETTA 4X4X8 INGR.CONTRALB.			3,31
52		5102299	CUSCINETTO D.17X40X12			14,86
53		9011607X	PRIGIONIERO			5,15
54		5602610	GRANO RIFERIMENTO			2,78
55		5304730	GUARNIZIONE			2,69
56		4909119	VITE			3,01
57		2606057	PIASTRINA PASSATUBO SU COP.			2,08
58		KA2395188	CARTER COPRIPIGNONE			12,35
59		K03794350	DISTANZ. 6,4X12,5X9 PE-HD NERO			1,39







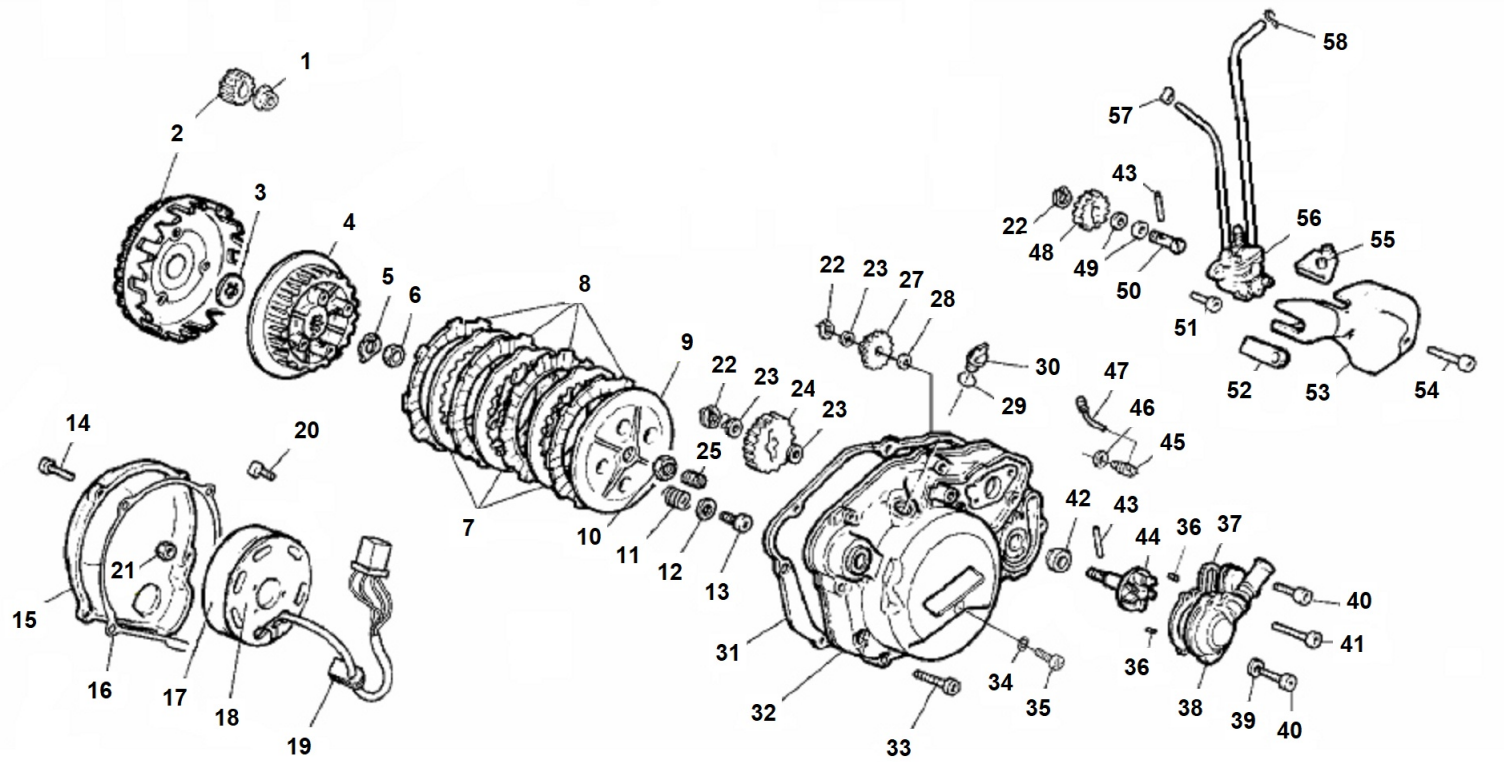













2-MOTOR CARTER - GEARBOX

N.		Part n°	Description	Notes	Notes	Taxable price (€)
60		5WX14D81	VASCHETTA CARBURATORE			0,00
61		5WXE1536	INGRAN.CONDUTTORE CONTRALBERO			87,24
62		5WXE6111	PIGNONE MOTORE Z-20	Z20		36,31
63		4903470	DADO M12X1,25			10,00
64		5WXE1531	INGRAN.CONDOTTO CONTRALB.Z=34			61,77
65		4906440	RONDELLA ACCIAIO			2,78
66		4903420	DADO M12X1 H=5 (CH.19) PR.80			4,63

3-CLUTCH - GENERATOR











3-CLUTCH - GENERATOR

N.		Part n°	Description	Notes	Notes	Taxable price (€)
1		4903470	DADO M12X1,25			10,00
2		5WXE6150	CAMPANA FRIZIONE			167,80
3		4904390	DISTANZIALE SOTTO TAMB. FRIZ.			14,55
4		5WXE637110	TAMBURINO FRIZIONE			38,73
5		4907000	RONDELLA DI FERMO			3,16
6		4903370	DADO M12X1,25			5,26
7		5WXE6324	DISCO FRIZIONE CONDUTTORE			19,62
8		5WXE6331	DISCO FRIZIONE CONDOTTO			14,19
9		5WXE635110	SPINGIDISCO FRIZIONE			32,38
10		4903240	DADO M14X1,25			4,01
11		9050120X	MOLLA FRIZIONE			4,67
12		9020105X	RONDELLA			3,09
13		9015705X	VITE			3,38
14		4908549	VITE TCE 5X20			0,69
15		2109123	COPERCHIO VOLANO NERO			29,40
16		5308860	GUARNIZIONE VOLANO			11,11
17		8203007	ROTORE S/GHIERA			130,01
18		8205014	STATORE VOLANO BAJA '06			132,33
19		2405120	GOMMINO ACCENSIONE			1,39
20		4909389	VITE T.B.E.I M4X10 C/FLANGIA			2,79

3-CLUTCH - GENERATOR

N.		Part n°	Description	Notes	Notes	Taxable price (€)
21		4903490	DADO 10X1,25			4,48
22		0303016	SEEGER PER ALBERO D.8			2,39
23		4916130	RONDELLA 8,2X15X1			3,23
24		4005780	INGRANAGGIO POMPA ACQUA			6,51
25		4908010	VITE REGISTRO FRIZIONE			5,44
27		4004787	INGRANAGGIO DOPPIO INTERMEDIO	Z13/24		6,36
28		4916096	RONDELLA ACC.BLU D.8,4X16X0,6			3,09
29		5301788	ANELLO O-RING			2,87
30		2470547	TAPPO ALIMENTAZIONE OLIO			3,06
31		5303640	GUARNIZIONE COPERCHIO FRIZIONE			16,24
32		2107380	COP.FRIZ.VERNIC.NERO C/PERNO			96,40
33		90110068	VITE TCCE M6X30			3,38
34		5304720	GUARNIZIONE VITE LIVELLO OLIO			2,57
35		4908420	VITE TCB M6X7 TAGLIO A CROCE			3,90
36		5604017	RULLO D. 4X10			0,69
37		5304000	GUARNIZIONE POMPA ACQUA			3,23
38		2106138	COPERCHIO POMPA ACQUA V/NERO			21,43
39		4917570	RONDELLA RAME			0,69
40		90110067	VITE TCCE M6X25			3,01
41		90110065	VITE TCCE M6X55			3,09

3-CLUTCH - GENERATOR

N.		Part n°	Description	Notes	Notes	Taxable price (€)
42		5305339	PARAOLIO 10X18X8			8,82
43		5604007	RULLO PER INGR. CONDOTTO POMPA			2,79
44		1HDE2450	PERNO POMPA ACQUA C/GIRANTE			24,40
45		5WXE5378	PONTE REGISTRO FILO			4,17
46		5304730	GUARNIZIONE			2,69
47		5WXE3228	TUBETTO DEVIATORE			7,53
48		4005757	INGRANAGGIO POMPA OLIO			3,97
49		4916096	RONDELLA ACC.BLU D.8,4X16X0,6			3,09
50		5WXE3226	PERNO PER POMPA OLIO			10,42
51		4908529	VITE			0,12
52		5WXE5379	GOMMINO X REGISTRO FILO P.OLIO			3,68
53		2107350	COPERCHIO NERO POMPA OLIO			12,42
54		90110059	VITE TCCE 5X35			0,00
55		2405334	GOMMINO POMPA OLIO			3,94
56		MM5WXE310011	POMPA OLIO COMPLETA PRICOL			113,10
57		90468021	FASCETTA			0,00
58		90467092	FASCETTA			0,00

4-GEARBOX SELECTOR

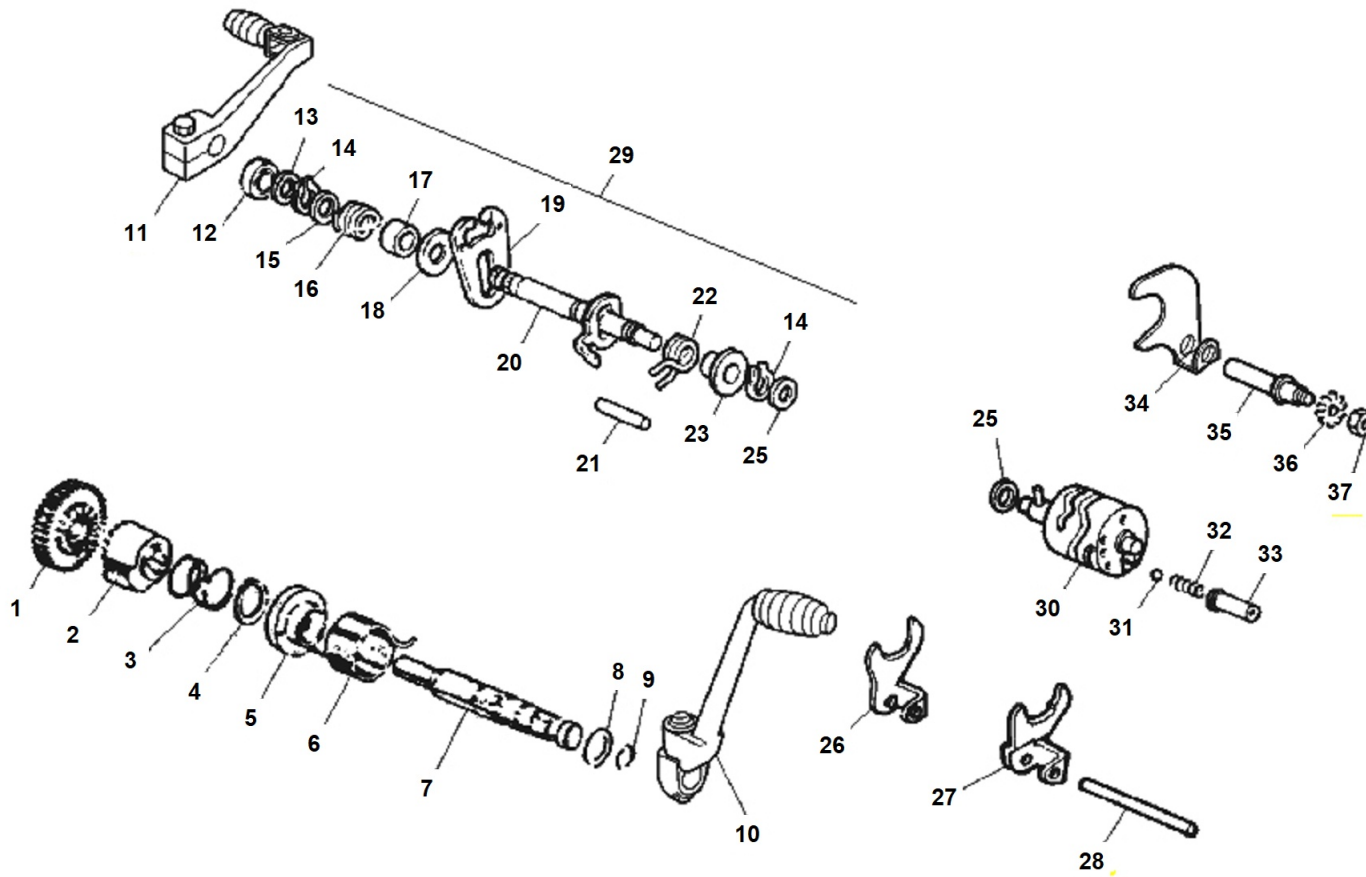

4-GEARBOX SELECTOR

N.		Part n°	Description	Notes	Notes	Taxable price (€)
1		4005351	INGRANAGGIO M/MOTO Z=21	Z20		32,37
2		4006621	INNESTO SCORREVOLE M/MOTO			18,75
3		4601489	MOLLA INNESTO SCORREVOLE M/M			5,44
4		0303366	ANELLO SEEGERPER ALBERO D.18			3,20
5		4701159	MOZZO MOLLA RICHIAMO LEVA M/M			14,04
6		4602362	MOLLA RICHIAMO LEVA M/MOTO			6,17
7		0101216	ALBERO MESSA IN MOTO			26,80
8		4906514	RONDELLA ACC.BLU D.16X25X0,4			0,69
9		5301047	ANELLO OR 12,5X1,5			2,84
10		8000301	PEDALE MESSA IN MOTO			35,62
11		8000311	PEDALE CAMBIO ALU			25,70
12		5305019	PARAOLIO BA D.12X22X7			6,22
13		4906426	RONDELLA			3,13
14		0303026	SEEGER			3,01
15		4906440	RONDELLA ACCIAIO			2,78
16		4601967	MOLLA FORCHETTA SELETTORE			6,67
17		9038712X0	DISTANZIALE D.12,4X14,4X11			8,34
18		4906800	RONDELLA 12,75X28X1,5			2,78
19		5WXE8141	FORCHETTA SELETTORI C/PERNI			25,58
20		5WXE8101	ALBERO SELETTORE C/PIASTRINA			52,19













4-GEARBOX SELECTOR

N.		Part n°	Description	Notes	Notes	Taxable price (€)
21		5609787	PERNO 8X48,3			4,17
22		4602027	MOLLA RICHIAMO			10,85
23		5101297	BOCCOLA GUIDA MOLLA			3,23
25		4906406	RONDELLA 10X16X0,6			3,13
26		3300070	FORCHETTA 2°-4° MARCIA			25,28
27		3300060	FORCHETTA 1°-3° MARCIA			25,28
28		5609020	PERNO GUIDA 7,8X103,5			12,24
29		0145083	ALBERO SELETTORE COMPLETO			64,62
30		5WXE8540	DESMODROMICO			72,18
31		9350006X01	SFERA D.9 MM			3,23
32		4603510	MOLLA PER SFERA SEGNAMARCE			4,19
33		5602070	BUSTA PORTASFERA			4,17
34		3300080	FORCHETTA 5°-6° MARCIA			25,28
35		5609010	PERNO 7,8X72			10,70
36		4906129	RONDELLA DIAM 7			0,69
37		4903059	DADO M7X5,5			2,69

5-ADHESIVES 2021



5-ADHESIVES 2021

N.		Part n°	Description	Notes	Notes	Taxable price (€)
1		K01521004	KIT ADES.EU5-50CC NERO MY21			91,46
1		K01521008	KIT ADES.EU5-50CC BIANCO MY21			91,46
2		K01521404	ADESIVO NERO CASSA-FILT MY21			6,25
2		K01521408	ADESIVO BIANCO CASSA-FILT MY21			6,25
3		K01521704	ADESIVO NERO PORTA-NR MY21			19,45
3		K01521708	ADESIVO BIANCO PORTA-NR MY21			19,45
4		K01521604	ADESIVO NERO CONVOGLIAT MY21			37,93
4		K01521608	ADESIVO BIANCO CONVOGLIAT MY21			37,93
5		K01521204	ADESIVO NERO PARASTELI MY21			10,42
5		K01521208	ADESIVO BIANCO PARASTELI MY21			10,42
6		K01521904	ADESIVO NERO PARAF-POST MY21			13,89
6		K01521908	ADESIVO BIANCO PARAF-POST MY21			13,89
7		K01521304	ADESIVO NERO PARAF ANT MY21			13,23
7		K01521308	ADESIVO BIANCO PARAF ANT MY21			13,23
8		K01521504	ADESIVO NERO MASCHERINA MY21			13,89
8		K01521508	ADESIVO BIANCO MASCHERINA MY21			13,89

ELECTRICAL SYSTEM

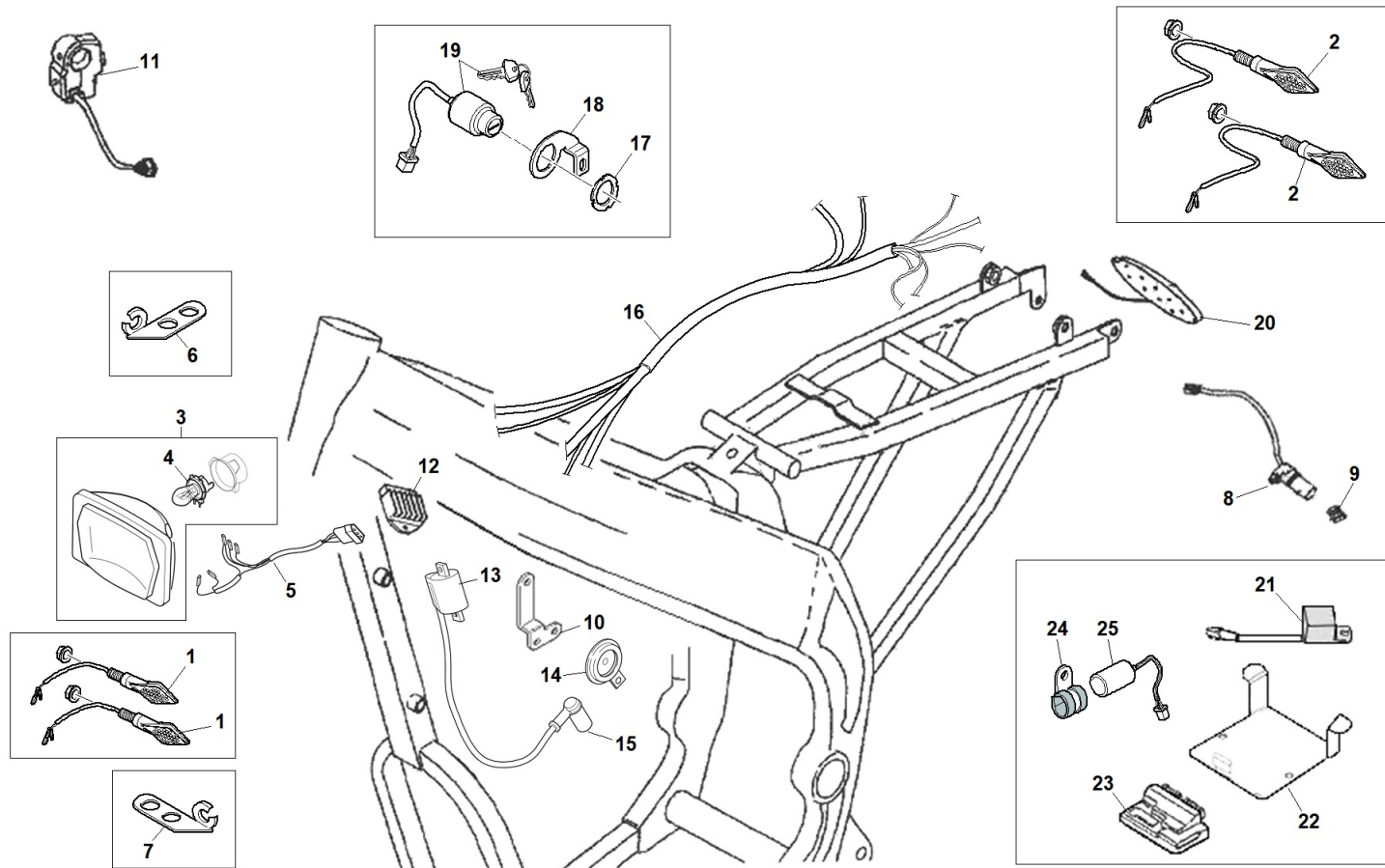

ELECTRICAL SYSTEM

N.		Part n°	Description	Notes	Notes	Taxable price (€)
1		K02820411	FRECCIA ANTERIORE MY20			14,55
2		K02820431	FRECCIA POSTERIORE MY20			14,89
3		K02310822	FARO ANTERIORE MASCHERINE CRM	MOTARD		50,59
4		W24111	LAMPADINA 12V 25/25W			4,17
5		K02810305	INTERFACCIA FARO CRM HM50	MOTARD		12,13
6		K02818290	SUPP.FRECCIA DX MOTARD	MOTARD		2,87
7		K02818295	SUPP.FRECCIA SX MOTARD	MOTARD		2,87
8		K03609182CH	VALVOLA SOLENOIDE			39,28
9		K03609184CH	FILTRO SU SOLENOIDE			5,55
10		K03406740	PIASTRINA SUPP.CLAXON			8,34
11		K02810200C	GR.COMMUTATORE S/PULS.MASSA			53,26
12		0706604	REGOLATORE DI TENSIONE			75,06
13		0702150	BOBINA ACCENSIONE "MORIC"			43,59
14		K02821147	CLACSON 12V 1.5A HORN			14,01
15		KMM12010	CAPPUCCIO CANDELA			10,92
16		K02821380	IMPIANTO ELETTRICO 50 EU5			183,02
17		K03510305	DISTANZ.COMM.ACC.NE SP.2,5 MM	<0120038		3,33
18		K03511070	SUPP.BLOCCH.CHIAVI 50 BASIC			4,86
19		K03510020	KIT SERRATURE + ACCESSORI			67,38
20		K02310091C	GRUPPO OTTICO A LED SPINATO			42,32







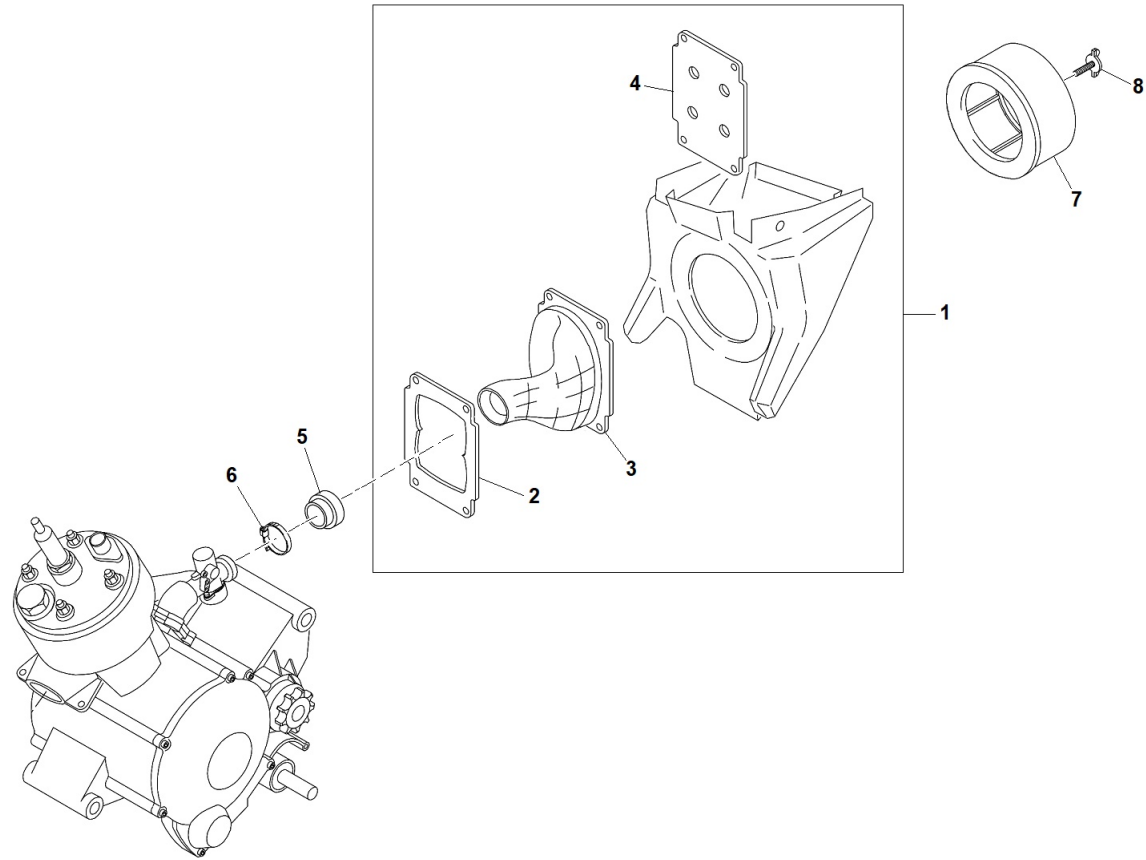

ELECTRICAL SYSTEM

N.		Part n°	Description	Notes	Notes	Taxable price (€)
21		YH2814210	INTERMITTENZA			15,99
22		K03419555	SUPP.CDI/INTER.IN C/FILTRO 125			12,68
23		0705446	CENTRALINA AM6 VENT EU-5			280,70
24		K01010030	PASSACAVO GOMM. D.30 FORO 6,5			2,32
25		K02810032	CONDENSATORE CON CONNETTORE			31,02

INTAKE









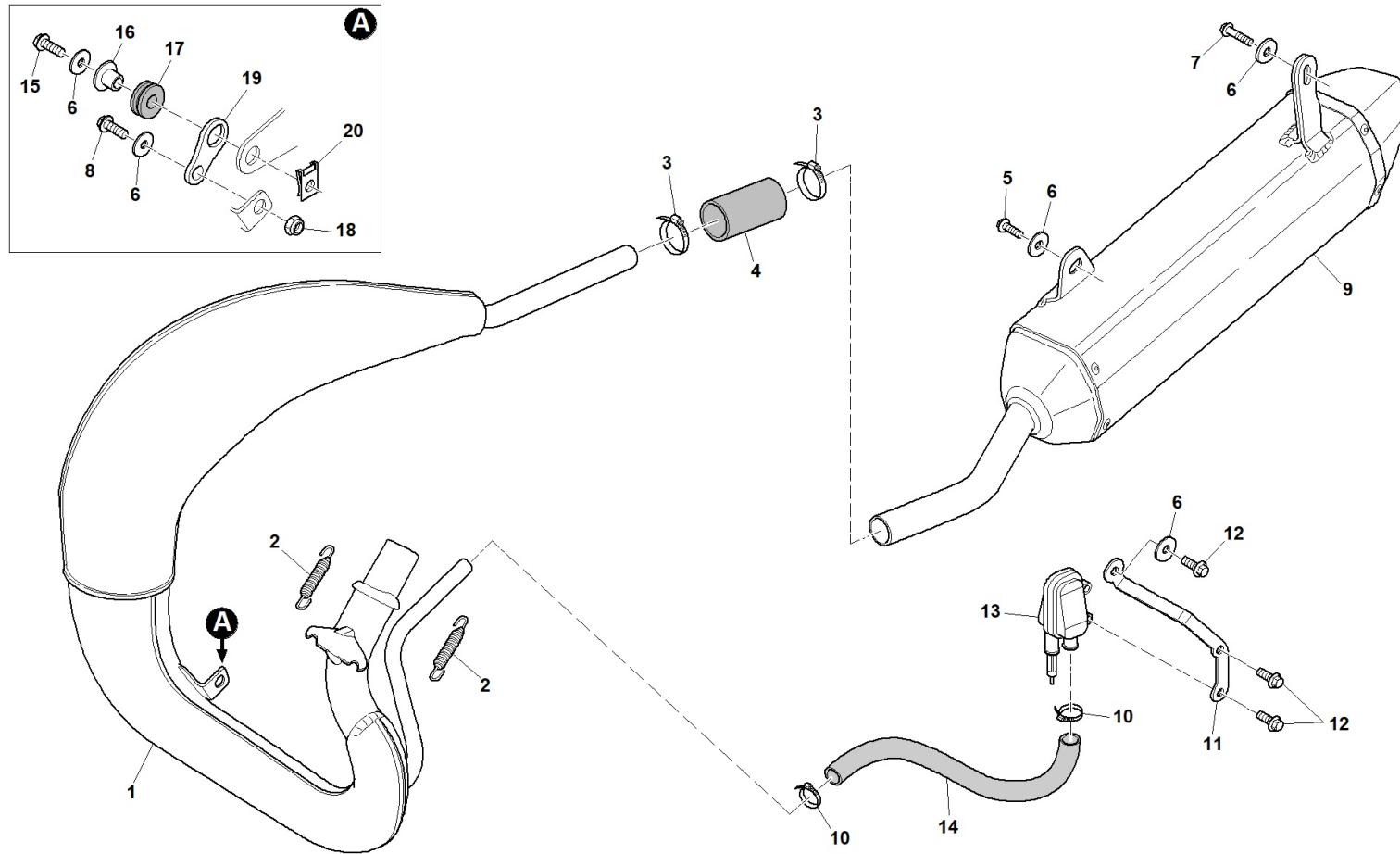









INTAKE

N.		Part n°	Description	Notes	Notes	Taxable price (€)
1		K02319760	CASSA FILTRO 50			80,70
2		K02394680	CONTROFLANGIA CASSA FILTRO			6,95
3		K01006330	CONDOTTO CASSA FILTRO HM50			57,55
4		K02394666	FLANGIA SUPPORTO FILTRO CRE 50			14,81
5		K02394670	RIDUZIONE MANICOTTO			8,34
6		K03405070	FASCETTA COLL/CASSA FIL. 50-70			4,19
7		K01594000	FILTRO CON GABBIA CRE 50			20,84
8		K02318675	VITE A GALLETTO M5X30			1,74

8-EXHAUST PIPE









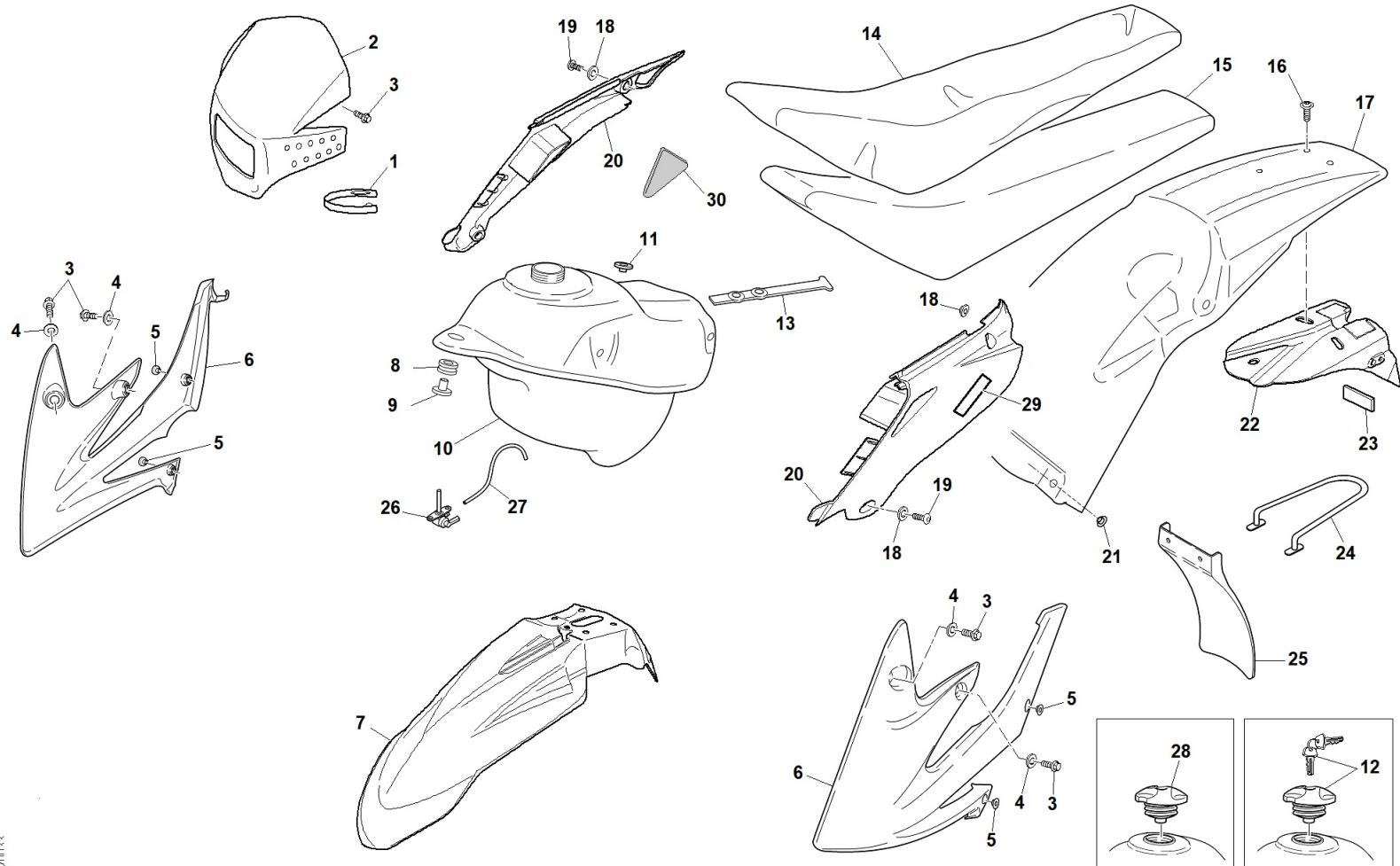









8-EXHAUST PIPE

N.		Part n°	Description	Notes	Notes	Taxable price (€)
1		K03621260	MARMITTA CATAL 50 EU5 MY21 V2			192,94
2		K03613700	MOLLA MARMITTA			0,90
3		TA3492115	FASCETTA TUBO RAD. 16X27 W2			1,49
4		K01001030	MANICOTTO IN SILICONE MARM/SIL			4,17
5		TEF06X016	VITE TEF 6X16 FLANGIATA ZNB			1,39
6		W00412	RONDELLA 6,5X18X1,5 DIN 9021			1,39
7		TEF06X020	VITE TEF 6X20 FLANGIATA			1,39
8		TEF06X020	VITE TEF 6X20 FLANGIATA			1,39
9		K03621240	SILENZIATORE 50 EU5 MY21			102,53
10		K03407278	FASCETTA STRINGITUBO			0,00
11		K03610430	SUPPORTO VALVOLA ARIA SECONDARIA			0,00
12		TEF06X010	VITE TEF 6X10 FLANGIATA ZNB			1,39
13		K03610190	VALVOLA AIS USC.PARALL. +FILTRO			22,92
14		K01011680	TUBO ARIA SECONDARIA 0,2MT			2,08
15		TEF06X025	VITE TEF 6X25 FLANGIATA			1,39
16		K03703210	BUSSOLA SILENZIATORE FORO D.7			2,78
17		W22164	GOMMINO SILENZIATORE EPDM NERO			4,17
18		KMM00006	DADO M6 GALLY			2,78
19		K01003935	SUPPORTO MARMITTA FE SP.5			3,48
20		W00441	CLIPS M6			1,39

BODYWORK



BODYWORK

N.		Part n°	Description	Notes	Notes	Taxable price (€)
2		K02310425	PORTAFARO CRM"LED VISION"NERA	MOTARD		105,84
2		K02310825	PORTAFARO "LED VISION"BIANCO	MOTARD		105,84
3		TEF06X010	VITE TEF 6X10 FLANGIATA ZNB			1,39
4		K03716350	BUSSOLA FISS.CONV./SERBATOIO			1,10
5		K03703350	BUSSOLA CONV./PORTANUM.LATER.			2,78
6		K02306450	COPPIA CONVOGLIAT.NERI 50X			45,15
6		K02307850	COPPIA CONVOGLIATORI BIANCO			45,15
7		K02321144	PARAFANGO ANT MOT MY21 NERO			34,07
7		K02321148	PARAFANGO ANT MOT MY21 BIANCO			34,07
8		K01003937	GOMMINO SUPPORTO SERBATOIO			1,82
9		K03703750	BUSSOLA SERBATOIO 50CC			2,48
10		K02306200	SERBATOIO BENZINA S/C NERO			72,22
11		K02303731	COLLARINO SERBATOIO/SELLA			2,08
12		K02318088	TAPPO SERBATOIO CON SERRATURA			32,50
13		KM1097800	ELASTICO CAVALLETTO			4,17
14		K02506215	COPRISELLA ROSSO "HM"	ROSSO		40,52
15		KS2511430	SELLA NERA HM TRAIL S/SCRITTE	Low Ride		93,53
15		KW2508200	SELLA ROSSA MARCHIO "VENT"	ROSSO		91,57
16		K01019026	VITE TBEI F/ROND.6X20 7381 ZNB			1,66
17		K02307460	PARAF.POSTER.NERO FORATURA			25,00

BODYWORK

N.		Part n°	Description	Notes	Notes	Taxable price (€)
17		K02307860	PARAF.POST.BIANCO FORATURA			25,00
18		K02503110	BUSSOLA SELLA 50			2,10
19		K01019027	VITE TBEI 8X20 F/ROND.7381 ZNB			1,39
20		W23207	COPPIA P/NUMERO LATER. BIANCHI			40,25
20		W23227	COPPIA PORTANUMERO LATER.NERI			40,25
21		K03703340	BUSSOLA FERRO CONV./CAPTATORE			1,39
22		K02310090C	PORTATARG CON FARO LED + SPINA			65,91
23		K02207110	CATADIOTTRO POSTERIORE ROSSO			5,55
24		SM00418V	MANIGLIA PASSEGGERO V/ARG.			16,67
25		K02303683	PATELLA PARAMONO NERA 50			13,45
26		K02415750	RUBINETTO BENZINA			26,40
27		K01696200	CANNUCCIA BENZINA MM.230			4,17
28		K02321187	TAPPO SERBATOIO SFIATO MY21			13,79
29		YH2217100	CATADIOTTRO ARANCIO			4,86
30		K01507030	ADESIVO LATERALE DX HM50			6,95

10-FORK 2

Verificare il proprio telaio nell'allegato "Scheda prodotto" premendo l'icona in alto a destra.



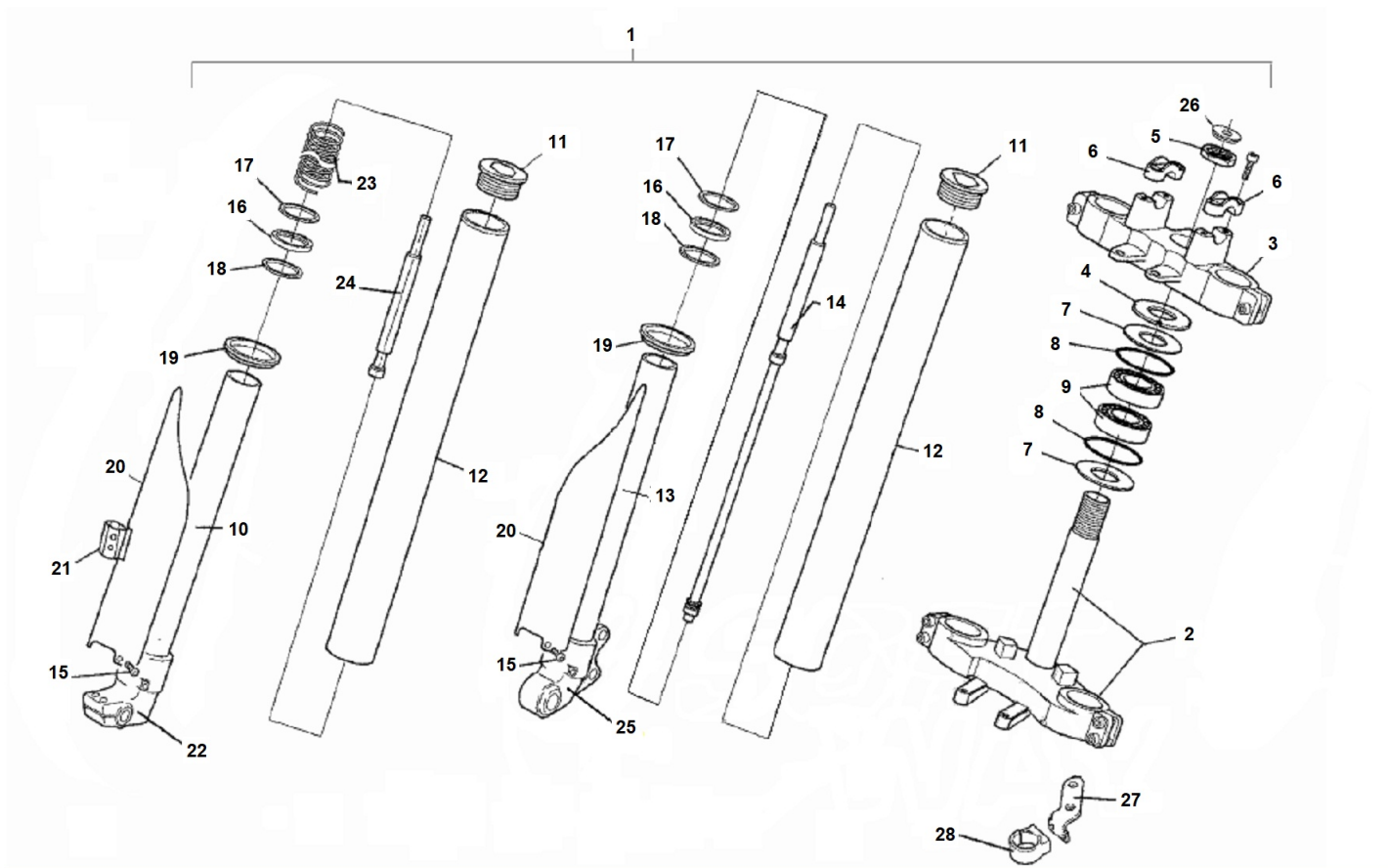









Se il telaio della vostra moto NON è fra quelli indicati nei file in allegato, consultare la tavola "Forcella 1"



10-FORK 2

N.		Part n°	Description	Notes	Notes	Taxable price (€)
1		K03719341	FORCELLA STD MAN.22 RIBASSATA			859,95
1		K03721241	FORCELLA PIED.MOD-PI.STD-MAN22			827,70
2		KLF41GR001	GR.PIASTRA INF.+CANNOTTO			229,22
3		KLF00141IAPSM	PIASTRA SUPER.FORCELLA USD HM			156,63
4		KLFPSF001Z	GHIERA CANNOTTO M25X100			24,54
5		KLFPSF002Z	DADO CANNOTTO HEX M25X100			16,83
6		KLFBM001M22M	CAVALLOTTO MANUBRIO HM D22			19,92
7		KA1243700	RONDELLA PARAPOLVERE FORCELLA			4,17
8		KW1008280	OR PARAPOLVERE 42X2,6 VITON 70			2,84
9		K03700200	CUSCINETTO STERZO 32005			11,81
10		KLF41CEB002C	STELO CROMATO ASSIEME MOLLE			244,49
10		KLF41CEB003C	STELO CROMATO LOW			244,49
11		KLF41GR002	TAPPO+ O-RING NBR70 40X3,5			63,90
12		KLF41GR006	GRUPPO FODERI			335,72
13		KLF41CEB001C	STELO CROMATO ASS. IDRAULICO			229,22
13		KLF41CEB003C	STELO CROMATO LOW			244,49
14		KLF41GR003	GRUPPO CARTUCCIA IDRAULICA			364,60
15		K01303146	VITE FISSAGGIO PARASTELO ZNB			2,64
16		KLF41PO001	PARAOLIO NOK 41X53X10X11,5			16,67
17		KLFPSV004	RONDELLA ALLUMINIO D52,8X43X2			19,45







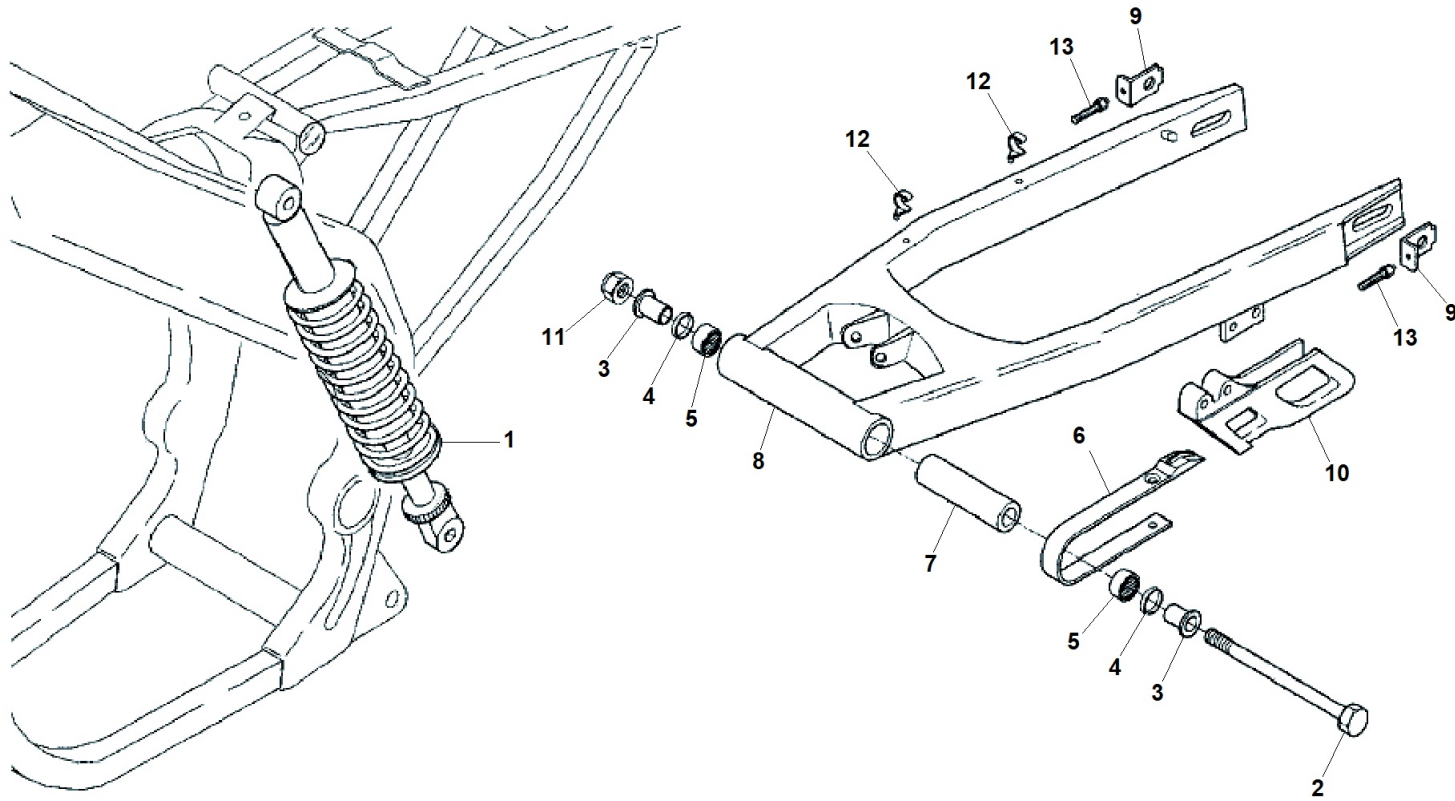







10-FORK 2

N.		Part n°	Description	Notes	Notes	Taxable price (€)
18		KLFPSS002	ANELLO SEEGER PARAOLIO D.1,8			11,47
19		KLF41RP001	RASCHIAPOLV.NOK 40,9X53,4X6X14			16,67
20		K02306375	COPPIA PARASTELI BIANCHI			23,61
20		SM00120	COPPIA PARASTELI NERI			25,00
21		K01303145	COPPIA PIASTR FISS TUBO FR.ANT			3,48
22		KLF41GR005	GR.PIEDE DX+ O-RING NBR70 38X3			163,68
23		KLF41MC001	MOLLA COMPRESSIONE L.585			60,64
24		KLF41GR007	GRUPPO ASSE ASSIEME MOLLE			63,90
25		KLF41GRPE005	PIEDINO STELO SINISTRO			160,91
26		KLFPSG001	TAPPO GOMMA PROTEZ.CANNOTTO			12,87
27		K01312395	SUPP.PASSACAVO TUBO FREN ANT			4,08
28		W23204	PASSACAVO TUBO FRENO-FARO ANT			2,78

11-IRON SWINGARM



11-IRON SWINGARM

N.		Part n°	Description	Notes	Notes	Taxable price (€)
1		K02710740	MONOAMMORTIZZATORE STD			154,35
1		K02719730	MONOAMMORTIZZATORE RIBASSATO	Low Ride		154,35
2		KA3994500	PERNO FORCELLONE 222MM			16,67
3		K03794215N	BUSSOLA FORCELLONE ZN NERA			8,62
4		K03794220	PARAPOLVERE GABBIA R. G22X28X4			2,78
5		K03794150	GABBIA RULLI FORCELL FE HK2220			6,95
6		KT2310195	PATTINO STRISCIACATENA RIALZAT			12,51
7		KA3495135	DISTANZIALE FORCELLONE			7,50
8		K03410015A	FORCELLONE FE V/ARG.			127,34
9		K03400070	PIASTRINA TENDICATENA			2,78
10		K01094475	CRUNA CATENA			15,42
11		KW3408056	DADO AUTOBL.M14X1,5 7474 ZNB			4,32
12		K01303310	GRAFFETTA FISSAGG.TUBO FR.POST			2,08
13		W00354	VITE TE 8X70 UNI 5739 CL. 8.8			2,78

12-HANDLEBARS - CONTROLS 2

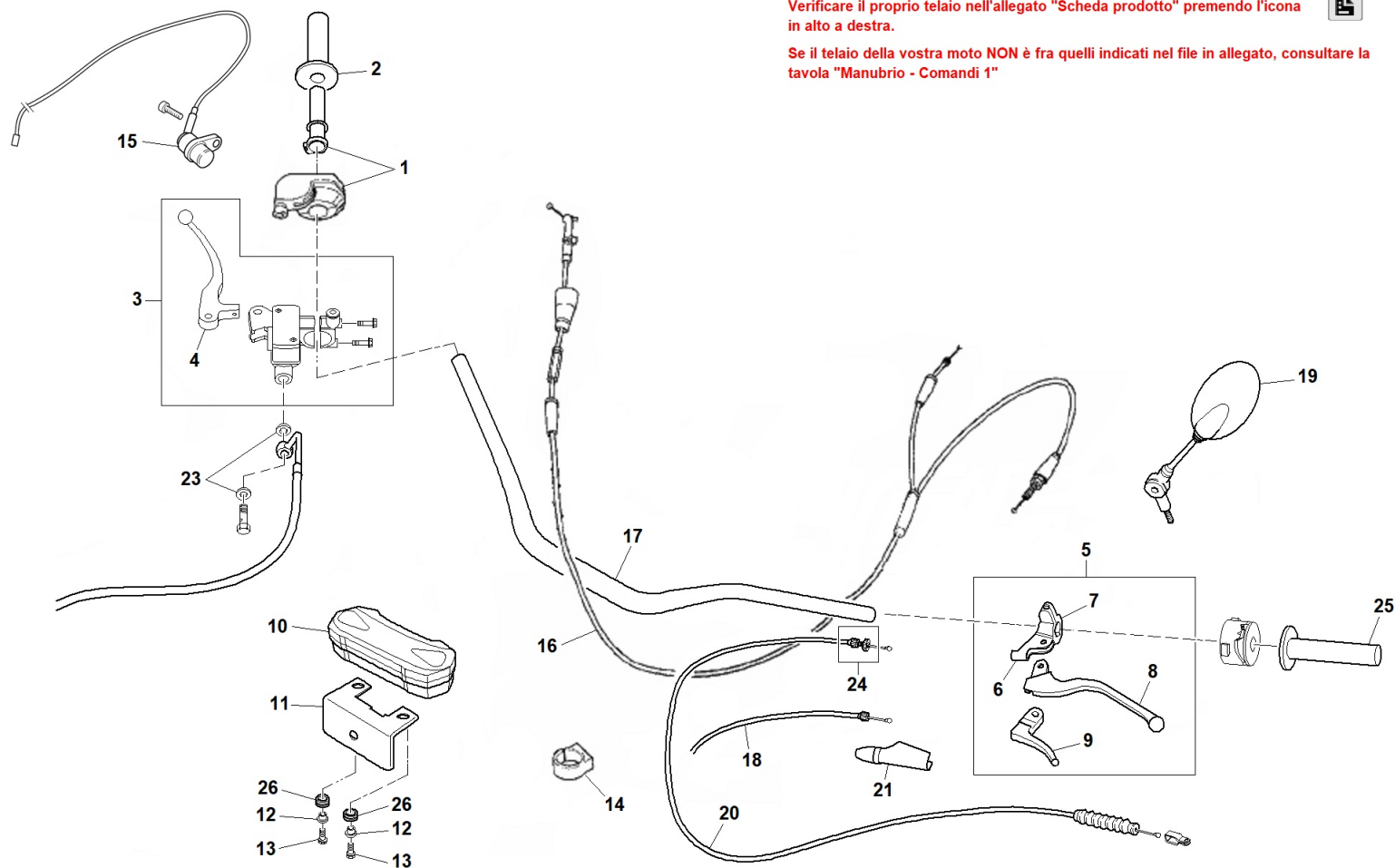

Verificare il proprio telaio nell'allegato "Scheda prodotto" premendo l'icona in alto a destra.

Se il telaio della vostra moto NON è fra quelli indicati nel file in allegato, consultare la tavola "Manubrio - Comandi 1"

12-HANDLEBARS - CONTROLS 2

N.		Part n°	Description	Notes	Notes	Taxable price (€)
1		K01094300	COMANDO GAS			14,99
2		K02094200	MANOPOLA DX NERA			5,68
3		K01320351	POMPA FRENO ANTERIORE			120,12
4		K01320355	LEVA FRENO RR MY20			42,21
5		KW2018500	COMANDO PORTALEVA SX C/STARTER			46,53
6		KW2008505	SUPPORTO LEVE FRIZIONE NUDO			21,25
7		K01311005	COLLARE P/SPECCHIO M10 SINISTR			6,25
8		KW2008502	LEVA FRIZIONE F125 NUDA			15,28
9		KW2008503	LEVA AVVIAMENTO F125			8,68
10		K05221245	STRUMEN CONTAKM EVEREST 50-EU5			93,71
11		K05221280	SUPPORTO CONTA-KM MY21			6,95
12		K05221285	BUSSOLA SUPP CONTA-KM FACOMSA			2,15
13		W28440	VITE TBEI 4X10 7380 10.9 ZNB			2,78
14		W23204	PASSACAVO TUBO FRENO-FARO ANT			2,78
15		KT5221195	SENSORE VELOCITA MY21			38,70
16		K02207010C	CAVO GAS MIX B-D-RR C/MOLLA			14,58
17		K02018455A	MANUBRIO ACCIAIO V/ARG.			26,15
18		K02212750	CAVO START HM50 B/D/RR/DCO			4,86
19		K02121620	SPECCHIETTO M10X1.25 FA-415 LH			27,02
20		K02216601	CAVO FRIZIONE			14,58

12-HANDLEBARS - CONTROLS 2

N.		Part n°	Description	Notes	Notes	Taxable price (€)
21		K02216801	CUFFIA DOPPIA IN GOMMA			3,75
23		W24340	RONDELLA AL 10X14X1,5			1,39
24		395502015HM	REGISTRO FRIZIONE DI			0,00
25		K02094100	MANOPOLA SX NERA			5,68
26		K01094505	GOMMINO RADIATORE			0,83

13-FRONT WHEEL 2

Verificare il proprio telaio nell'allegato "Scheda prodotto" premendo l'icona in alto a destra.

Se il telaio della vostra moto NON è fra quelli indicati nel file in allegato, consultare la tavola "Ruota anteriore 1"

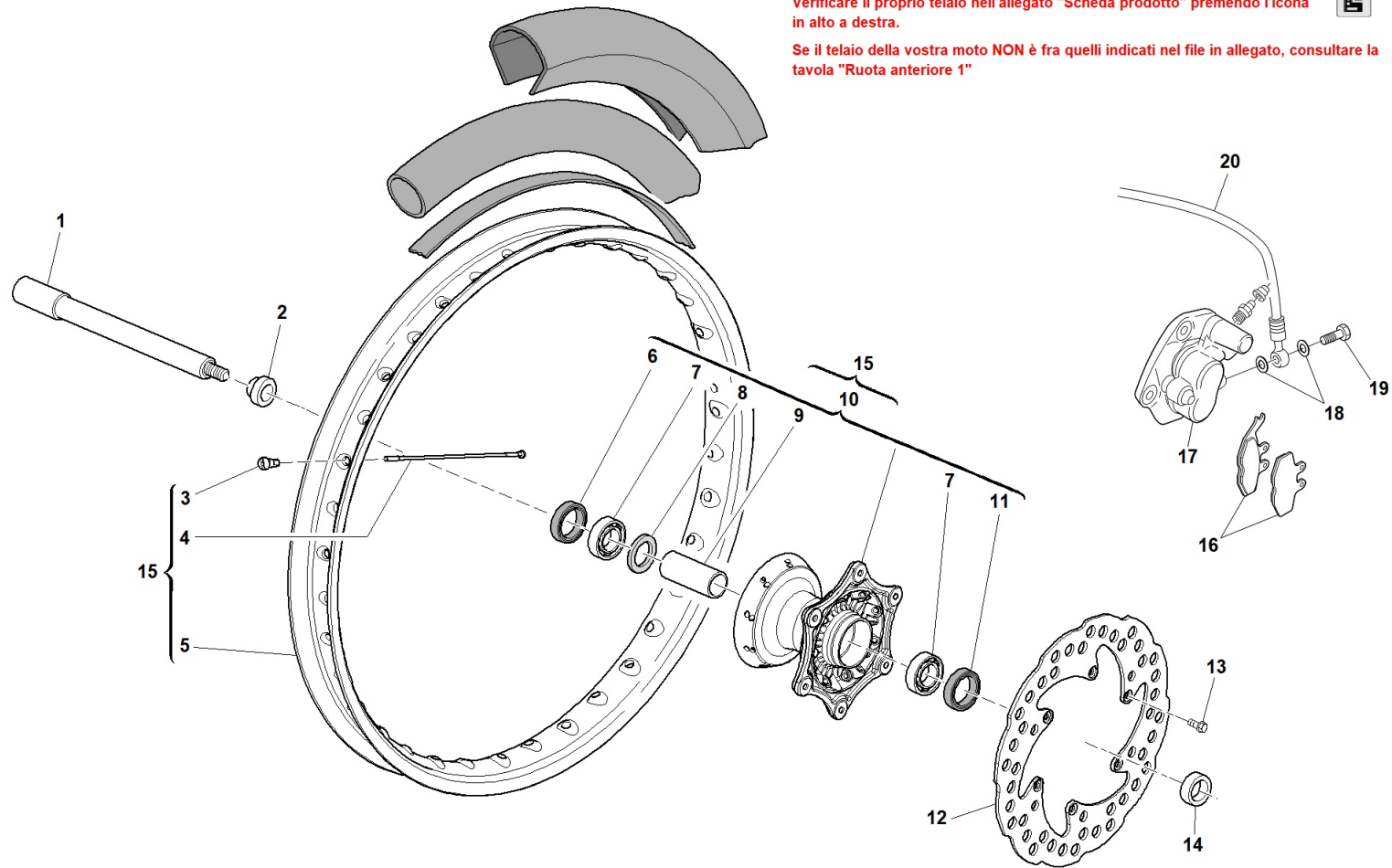

13-FRONT WHEEL 2

N.		Part n°	Description	Notes	Notes	Taxable price (€)
1		K01110110	PERNO RUOTA ANTERIORE MY20			14,58
2		K01120581	DISTANZIALE POSTERIORE DX			0,00
3		KW1118MF93	NIPPLO ANTERIORE MOTARD	MOTARD - 17"		2,94
4		KW1118MF9E	RAGGIO ANT. MOTARD ESTERNO	MOTARD - 17"		5,72
5		KW1118MF7	CERCHIO 2.5X17	MOTARD - 17"		140,07
6		KW1118EF86	PARAOLIO 47X25X7			14,16
7		KW1118EF83	CUSCINETTO 47X20X14			14,31
8		KW1118EF81	ANELLO DI SUPPORTO			0,00
9		KW1118EF82	DISTANZIALE INTERNO			15,02
10		KW1118EF8	MOZZO ANTERIORE			88,15
11		KW1118EF84	PARAOLIO 47X32X7			14,16
12		K01320300	DISCO FRENO ANTERIORE D.300			100,08
13		W00464	VITE TBEI 6X14 7380 10.9 ZNB			2,78
14		K01111245	DISTANZ.RUOTA POST.SX SP.16,0			3,15
15		KW1118MF0	RUOTA ANT. 250X17 MOTARD 125	MOTARD - 17"		241,94
16		K01320353	COPPIA PASTIGLIE FRENO ANTER			37,49
17		K01320352	PINZA FRENO ANTERIORE			106,37
18		W24340	RONDELLA AL 10X14X1,5			1,39
19		TA4300002	DADO RACCORDO TUBO FD			1,39
20		K01320356	TUBO PINZA-POMPA ANT MY20 RR			38,85







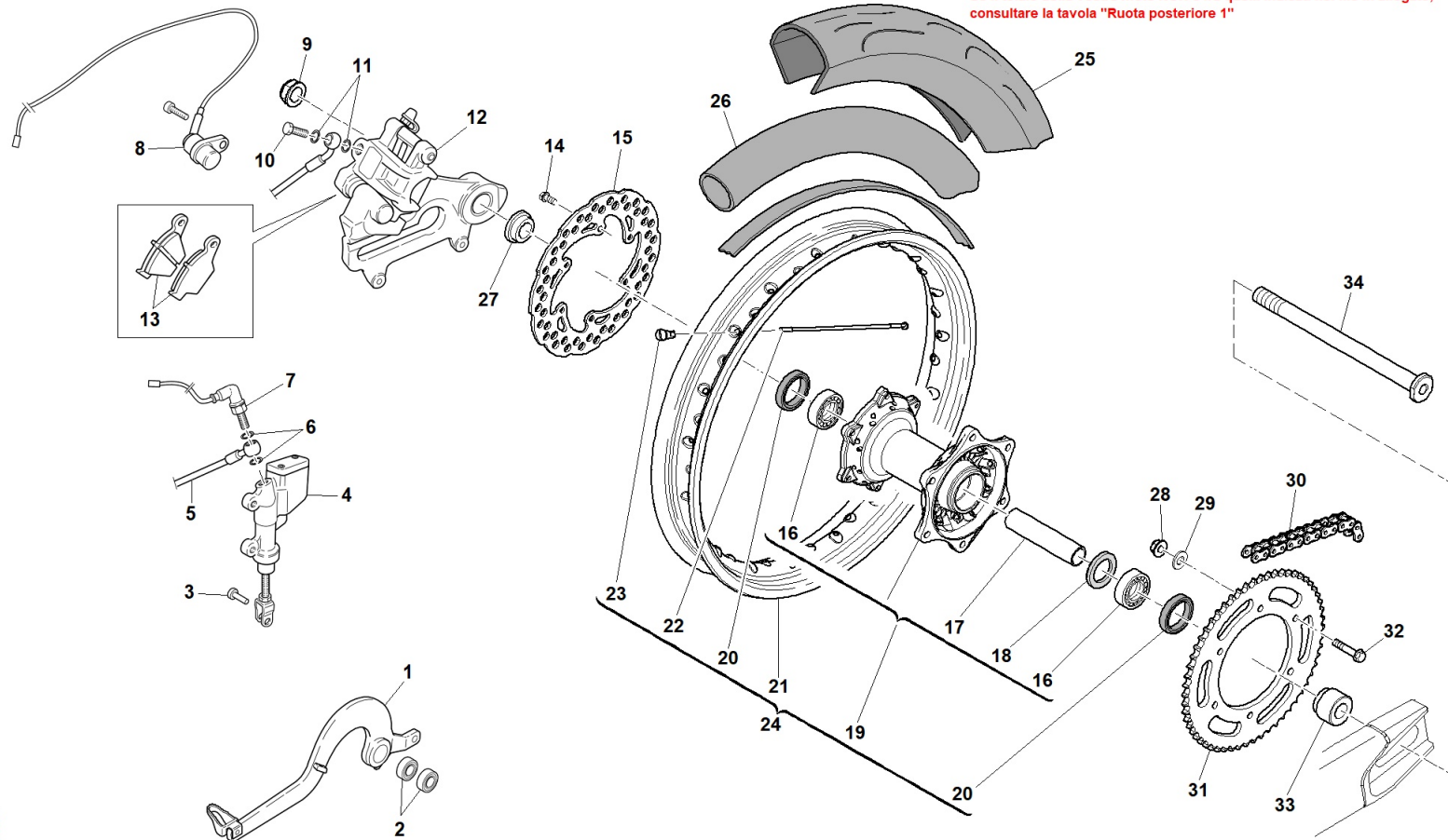





14-REAR WHEEL 2

Verificare il proprio telaio nell'allegato "Scheda prodotto" premendo l'ic
in alto a destra.















Se il telaio della vostra moto NON è fra quelli indicati nel file in allegato,
consultare la tavola "Ruota posteriore 1"



14-REAR WHEEL 2

N.		Part n°	Description	Notes	Notes	Taxable price (€)
1		KW3410195A	PEDALE FRENO POSTERIORE FE VER			52,82
2		K03410380	CUSCINETTO 608 2RS PED.FRENO			1,39
3		K03908100	SPINA FORCELLINO PEDALE FRENO			2,08
4		K01320361	POMPA FRENO POSTERIORE			101,33
5		K01320367	TUBO FRENO POST			0,00
6		W24340	RONDELLA AL 10X14X1,5			1,39
7		W03970	INTER IDROSTOP PASSO 1,25 L275			13,89
8		KT5221195	SENSORE VELOCITA MY21			38,70
9		W00447	DADO AUTOBLOC. 16X1,5 MB BASSO			2,78
10		TA4300002	DADO RACCORDO TUBO FD			1,39
11		W24340	RONDELLA AL 10X14X1,5			1,39
12		K01320362	PINZA FRENO POSTERIORE			113,01
13		K01320363	COPPIA PASTIGLIE FRENO POSTER			34,91
14		W00464	VITE TBEI 6X14 7380 10.9 ZNB			2,78
15		K01318220	DISCO FRENO POST. D220 WAVE			57,25
16		KW1118EF83	CUSCINETTO 47X20X14			14,31
17		KW1118ER82	DISTANZIALE INTERNO			21,53
18		KW1118ER81	ANELLO DI SUPPORTO			0,00
19		KW1118ER8	MOZZO POSTERIORE			100,17
20		KW1118EF84	PARAOLIO 47X32X7			14,16

14-REAR WHEEL 2





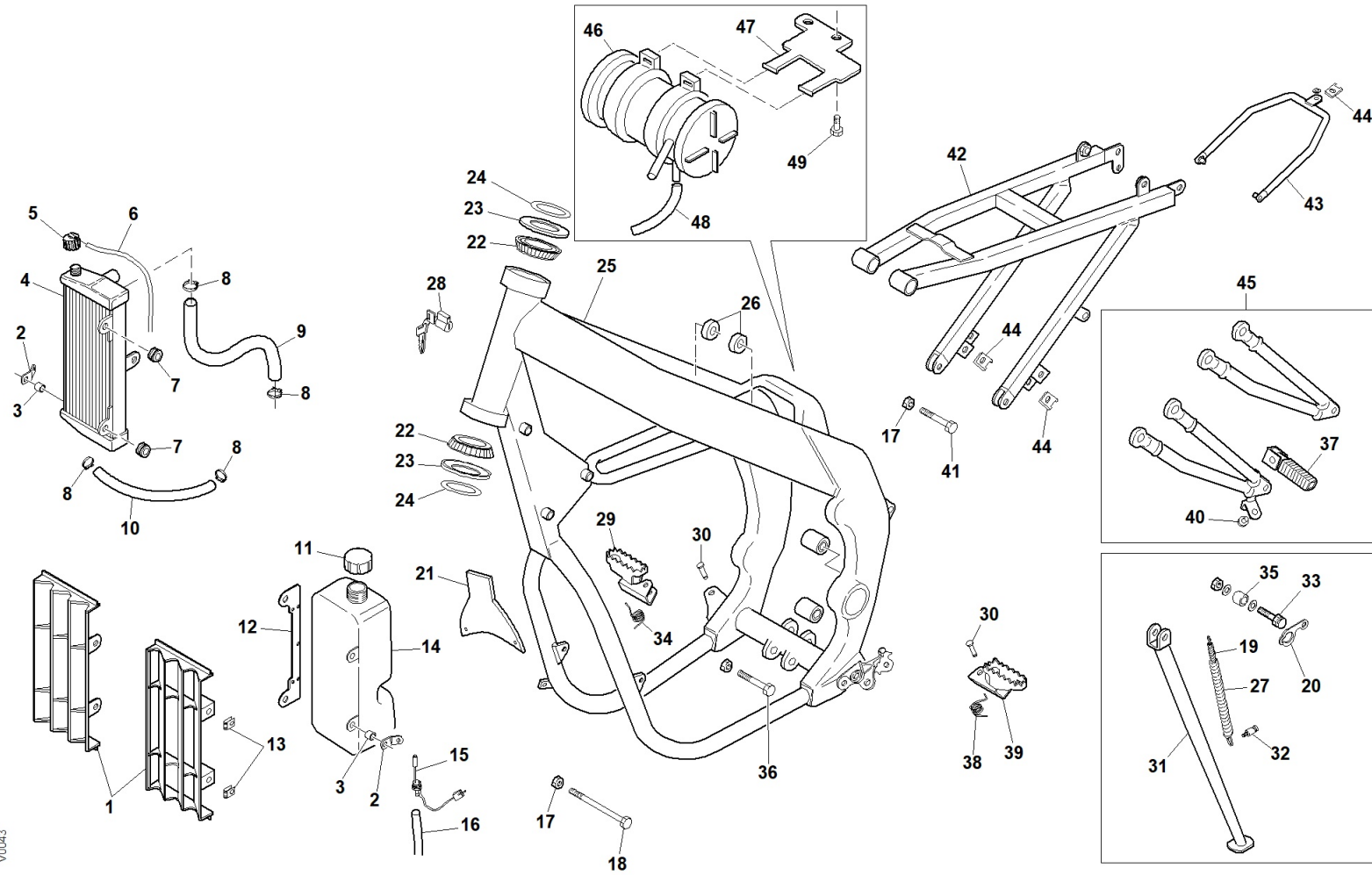

N.		Part n°	Description	Notes	Notes	Taxable price (€)
21		KW1118MR7	CERCHIO POSTERIORE 3,50X17	MOTARD - 17"		151,54
22		KW1118MR9F	RAGGIO POST. MOTARD INTERNO	MOTARD - 17"		3,51
23		KW1118MF93	NIPPLO ANTERIORE MOTARD	MOTARD - 17"		2,94
24		KW1118MR0	RUOTA POST. 350X17 MOTARD 125	MOTARD - 17"		280,15
25		13070M39	COPERTURA POST.130/70-17 TL62T	120/130/70-17"		65,42
26		K0112117P	CAMERA 130/70-17 TR6			12,51
27		KW1118480	DIST. POSTERI SX/DX 125 AL/FE			3,86
28		KW1208026	DADO AUTOBL.BASSO INS.INOX M8			4,24
29		W00347	RONDELLA 8,4X17X1,6 UNI 6592			1,39
30		K01909100	CATENA CON GIUNTO-138 MAGLIE			41,90
31		K01220160	CORONA 428 FE NERA Z60			43,00
32		KT1210025	VITE FISSAGGIO CORONA M8X29			4,19
33		K01111245	DISTANZ.RUOTA POST.SX SP.16,0			3,15
34		K01103050	PERNO RUOTA POST 228MM-M16X1.5			17,02

FRAME



V0043











FRAME

N.		Part n°	Description	Notes	Notes	Taxable price (€)
1		K07094250	GRIGLIA RADIATORE			8,34
2		KA3406420	PIASTRINA RADIATORE/CONVOGLIAT			4,17
3		KA3406430	BUSSOLA PIASTRINA RAD/CONVOGL.			1,39
4		K07018100	RADIATORE DX 50CC			121,28
5		K07018150	TAPPO RADIATORE TONDO 1.4			12,79
6		K01612950	TUBO COPOLAN UML MM 5X9 ROTOLO			4,59
7		K01094505	GOMMINO RADIATORE			0,83
8		TA3492115	FASCETTA TUBO RAD. 16X27 W2			1,49
9		K01003620	TUBO ACQUA RAD./TESTA BAJA/DER			8,99
10		K01003640	TUBO ACQUA RADIATORE/POMPA			7,11
11		K02300030	TAPPO SERBATOIO OLIO			4,19
12		K03401010	SUPPORTO SERBATOIO OLIO			7,22
13		K03612131	CLIPS M5 CORTA ZNB(CR3)			1,39
14		K02311020	SERBATOIO OLIO MISCELAT NERO			30,32
15		K02311050	SONDA OLIO			20,79
16		2403367	TUBO ENTRATA OLIO			4,38
17		WW945	DADO M8 ALTO			0,00
18		TEF08X100	VITE TEF 8X100 FLANGIATA			1,39
19		K03806851	MOLLA ESTERNA CAVALLETTO			4,44
20		KA3406120	PIASTRINA AGGANCIO MOLLA CAVAL			4,17

FRAME





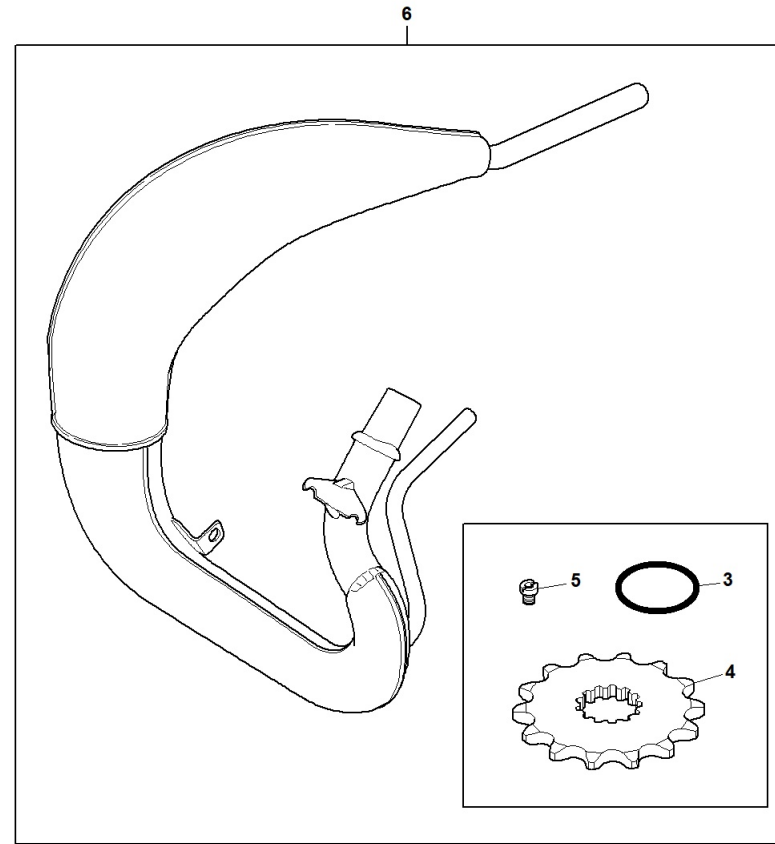
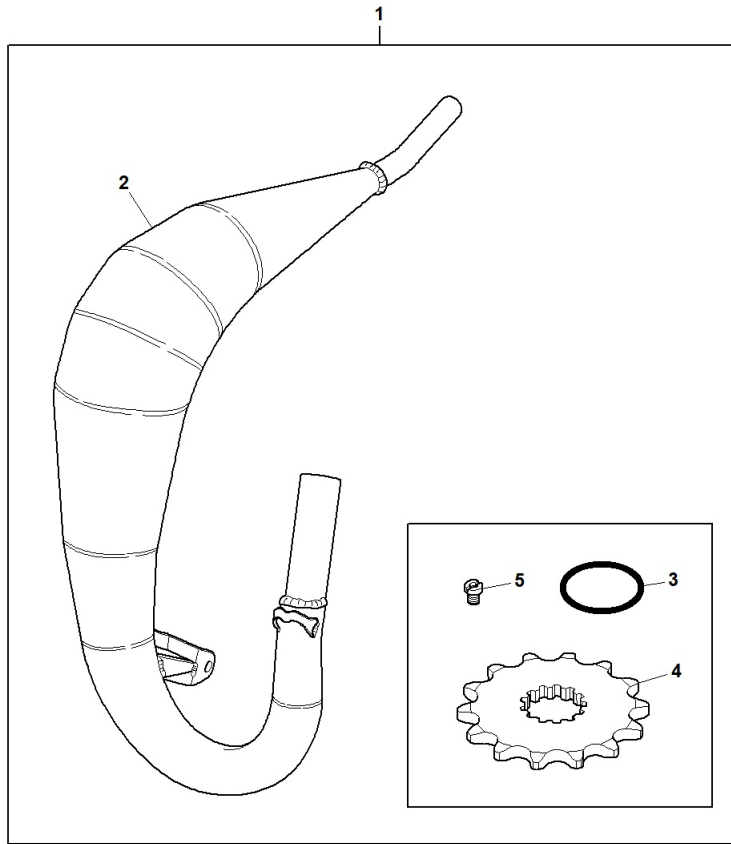

N.		Part n°	Description	Notes	Notes	Taxable price (€)
21		K02306510	PROTEZIONE CILINDRO 50 X ALU			12,51
22		K03700200	CUSCINETTO STERZO 32005			11,81
23		KA1243700	RONDELLA PARAPOLVERE FORCELLA			4,17
24		K01006277	OR PARAPOLVERE CUSC.FORC.B/D			1,39
25		K03418025A	TELAIO FE 50 VERN/ARG			445,68
26		K01006665	SILENTBLOCK GRUP. APPOGG SERBA			2,15
27		K03806850	MOLLA INTERNA CAVALLETTO			4,17
28		K03510020	KIT SERRATURE + ACCESSORI			67,38
29		KA3406501	PEDANA POGGIPIEDI DX.			19,85
30		KS3411520	PIOLO PEDANA POGGIPIEDI			2,08
31		K03407045	CAVALLETTO ALU CM34			43,00
32		K03706335	PIOLO FISS.MOLLA CAV. M5 LUNGO			2,94
33		K03706315	VITE FISSAGGIO CAVALLETTO			6,95
34		K03806500	MOLLA TORSIONE 2.5 DX V1			2,78
35		K03707355	BUSSOLA CAVALLETTO ZNB			4,86
36		TEF08X100	VITE TEF 8X100 FLANGIATA			1,39
37		KW3408400	COPPIA PEDANE PASSEGGERO			28,00
38		K03806501	MOLLA TORSIONE 2.5 SX V1			2,78
39		KA3406500	PEDANA POGGIPIEDI SX			19,85
40		K01094665	GOMMINO APPOGGIO			1,39

FRAME

N.		Part n°	Description	Notes	Notes	Taxable price (€)
41		TEF08X100	VITE TEF 8X100 FLANGIATA			1,39
42		K03419160A	CODINO PER TELAIO FE VERN.ARG.			88,41
43		K03418050A	SUPP.PARAFANGO POST. ZNB			20,84
44		W00441	CLIPS M6			1,39
45		K03410105	KIT PEDANE PASSEGGERO B/D (FE)			78,49
46		K03621650	GRUPPO CANISTER MY21 50CC			18,30
47		K03621655	SUPPORTO CANISTER MY21 ALU			10,92
48		K03621660	TUBO CANISTER 4,5X8,5 COPOLAN			4,63
49		W00492	VITE TBEI 8X16 ISO 7380 C.10.9			2,78



16-RELEASE KIT 2021

N.		Part n°	Description	Notes	Notes	Taxable price (€)
1		SP9919150K	KIT RACING 50 MY2019			180,33
2		SP3619150	MARMITTA RACING 2019			0,00
3		5301759	ANELLO OR D.25,7X2,62 "VITON"			1,39
4		K01295013	PIGNONE Z 13	Z13		22,58
5		D6413105	GETTO MAX 105			4,52
6		SP9919059K	KIT USO COMPETIZIONE 50 MY2019			135,24